

CERAMIC RESONATORS

Built-in capacitor types

SMD-version KX-ZTT CR series

model	KX-ZTT CR
frequency range	4,0 ~ 8,0 MHz
internal capacitance C ₁ , C ₂	15 pF
frequency tolerance at +25°C	± 0,5%
frequency stability at -25 ~ +85C	± 0,3%
aging for 10 years	± 0,3%
resonant resistance max.	40 ohm
test circuit IC	TC 74 HCU04
lead-free	started from date code May, 2005
contents of reel	3000 pcs.
part no.	12.99100 ~ 12.99900

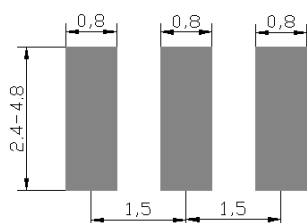
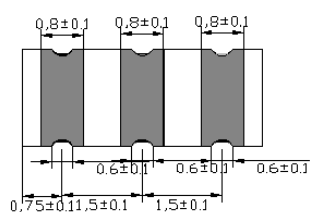
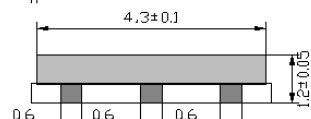
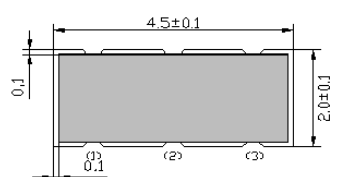

suggested soldering pad

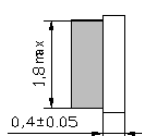

soldering condition

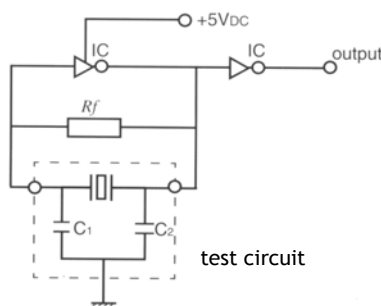
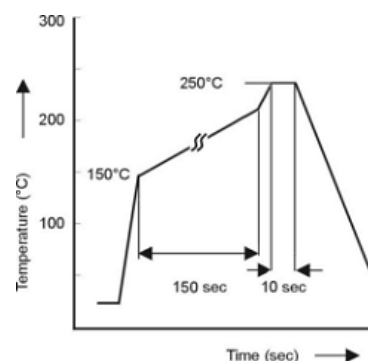

test circuit

tape specification

